

CREAFORM
ACCESSORY AND
SERVICES CATALOG

CREAFORM

AsorCAD[®]
Expertos en tecnología 3D

AMETEK[®]
ULTRA PRECISION TECHNOLOGIES

EXPLORE OUR CUSTOMER SERVICES

Along with its portable 3D measurement technologies, Creaform strives to provide you with efficient and reliable tools to help you get the work done in the shortest times possible. Our accessories offer a tailor-made solution and have been developed to meet the specific needs of our customers' wide range of applications—all while ensuring seamless integration in your processes.

All of Creaform's high-quality accessories are underpinned by high quality standards, ensured by innovative R&D and testing to optimize and significantly enhance your turnaround times and profitability. In addition, they integrate seamlessly with our technologies. Contact our after-sales agents to get a quote, place an order or find answers to your questions.

Let us help you make the most of your Creaform solutions.

1

Do you need
METROLOGY SERVICES

[Go to page 3](#)

2

Do you need
E-LEARNING & TRAINING

[Go to page 4](#)

3

Do you need
ACCESSORIES

[Go to page 5](#)

METROLOGY SERVICES

**SKILLED RESOURCES,
POWERFUL TECHNOLOGIES,
OUTSTANDING WORK.**

Our multidisciplinary team of over 100 experienced application engineers and metrologists has earned a reputation for effectiveness, quality, and professionalism. You can count on our experts to provide metrology services around the globe, under tight deadlines and strict quality standards.

Our commitment: coming up with the most effective 3D measurement technologies and work methods including large-scale projects.

[Learn more](#)

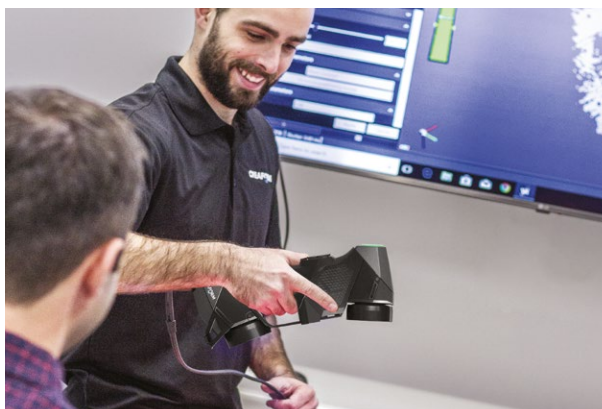

MEASUREMENT & CALIBRATION SERVICES

Our metrology experts have extensive knowledge of advanced cutting-edge measurement technologies, thus truly optimizing their use.

- 3D scanning (any material and size)
- Reverse engineering
- Dimensional inspection
- Robot and fixture calibration
- Machine alignment
- Statistical analysis

APPLICATION DEVELOPMENT SERVICES

Our application experts will introduce complete solutions to your engineering processes and production environment, enabling you to maximize your investment.

- Custom measurement solution integration
- Software and user interface programming
- Automated and robotized cell
- Production line inspection
- Turnkey solution implementation

TRAINING & CONSULTANCY SERVICES

Whether you are temporarily short on staff, want to ensure your resources are properly trained or want to extend your service offer, you can trust Creaform metrology experts.

- Inspection routine optimization
- Short-term staff outsourcing & mentoring
- Manpower skills development
- Technology upgrade assistance
- Metrology-related training
- Creaform technology training

E-LEARNING & TRAINING

DIMENSIONAL METROLOGY

PROBE MEASUREMENT

3D SCANNING MEASUREMENT

REVERSE ENGINEERING

COMPUTER-AIDED SURFACE
MODELING AND DESIGN

PIPELINE INTEGRITY ASSESSMENT

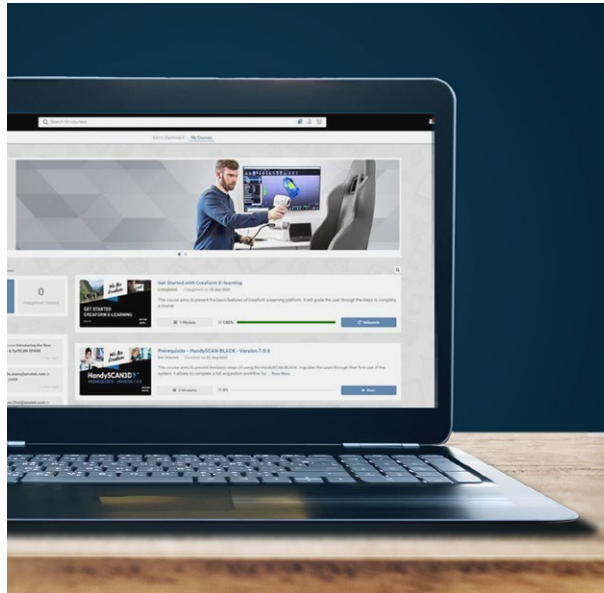

E-LEARNING OFFER

These course aims to present the theory associated with your Creafom technology and VXelements acquisition software of Creafom. This training combines learning, hands-on, and follow-up, all of which online, to maximize knowledge transfer. The idea behind this approach is to ensure customers get the most out of their technologies and maximize their experience.

Objectives:

- Perform quality scans using Creafom system
- Apply efficient workflow for the application
- Demonstrate technical expertise to ensure equipment is used advisedly

[Learn more](#)









CREAFORM TRAINING OFFER

Creafom's training sessions cover a wide array of metrology-related topics and they can take place at a Creafom office, at your own place, or at any other venue you choose. Plus, the format is very flexible:

- Difficulty level: basic, advanced, expert sessions, based on students' experience
- Theory and practice components: tailored to clients' specific needs and projects
- Duration: varies based on topics addressed, student learning capacity or clients' requirements
- Multilingual: available in English, French, German, Spanish, Chinese and Japanese
- In-business support

[Learn more](#)

ACCESSOIRES

 CABLES, CONNECTIONS & POWER SUPPLIES	07
Cables	08
Connections	11
Power Supplies	13
Batteries	14
 LAPTOPS	15
Laptops	16
 TARGETS	17
Legend	18
Coded Targets	19
Positioning Targets	20
Optical Reflectors	21
 PROBING	22
Probes	23
Special Tools	26
 CASES AND SUPPORTS	28
Carry-on Cases	29
Supports	30
 VALUE-ADDED	33

SYSTEM GENERATIONS

PRODUCT	FAMILY	GENERATION	MODEL	END OF SUPPORT	ITEM SERIAL NUMBER FORMAT
	MetraSCAN 3D-R	1 st Gen.	MetraSCAN 70-R MetraSCAN 210-R	01-avr-21	62rxxx 63rxxx
	HandyPROBE	2 nd Gen.	HandyPROBE	01-avr-21	72rxxx 77rxxx 78rxxx
	C-Track	2 nd Gen.	C-Track 380 C-Track 780 C-Track 1480	01-avr-21	70rxxx 75rxxx 76rxxx
	MetraSCAN 3D	2 nd Gen.	MetraSCAN 70 MetraSCAN 210	01-avr-21	53rxxx 56rxxx
	MaxSHOT 3D	1 st Gen.	MaxSHOT	01-avr-21	80rxxx
	MetraSCAN 3D-R	2 nd Gen.	MetraSCAN 750-R Elite	TBD	906rxxx
	HandySCAN 3D	2 nd Gen.	HandySCAN 300 HandySCAN 700 HandySCAN 307	TBD	65rxxx 66rxxx
	Go!SCAN 3D	2 nd Gen.	Go!SCAN 20 Go!SCAN 50	TBD	64rxxx 67rxxx
	HandyPROBE	3 rd Gen.	HandyPROBE Next	TBD	902rxxx
	C-Track	3 rd Gen.	C-Track C-Track Elite	TBD	87rxxx
	MetraSCAN 3D	3 rd Gen.	MetraSCAN 350 MetraSCAN 750 MetraSCAN 357	TBD	903rxxx 904rxxx 950rxxx
	MaxSHOT 3D	2 nd Gen.	MaxSHOT Next MaxSHOT Next Elite	TBD	914rxxx 915rxxx
	HandySCAN 3D	3 rd Gen.	HandySCAN BLACK HandySCAN BLACK Elite	TBD	926rxxx 927rxxx
	Go!SCAN 3D	3 rd Gen.	Go!SCAN SPARK	TBD	922rxxx
	C-Track	4 th Gen.	C-Track	TBD	942rxxx
	MetraSCAN 3D	4 th Gen.	MetraSCAN BLACK MetraSCAN BLACK Elite	TBD	938xxxx 939rxxx
	MetraSCAN 3D-R	4 th Gen.	MetraSCAN-R BLACK MetraSCAN-R BLACK Elite	TBD	940rxxx

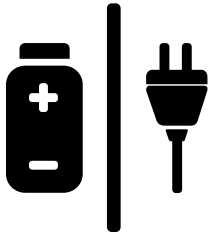

CABLES, CONNECTIONS & POWER SUPPLIES

From the shop floor to our clients' wide variety of industries and applications. They have been tested and approved for use in conjunction with Creaform solutions, which ensures perfect interaction between the product and accessory.



-
- [08 / Cables](#)
 - [11 / Connections](#)
 - [13 / Power Supplies](#)
 - [14 / Batteries](#)



USB 3.0 CABLE 4-m

ACC-CRE-CAU4

4-m (13-ft) USB 3.0 cable, connecting the scanner to the laptop or the controller

Compatible with: HandySCAN 3D (3rd Gen.), Go!SCAN 3D (3rd Gen.)



USB 2.0 CABLE 4-m

ACC-G3D-4USB

4-m (13-ft) USB 2.0 cable, connecting the scanner to the laptop.

Compatible with: Go!SCAN 3D (2nd Gen.)



USB 3.0 CABLE 4-m

ACC-H3D-CUSB

4-m (13-ft) USB 3.0 cable, connecting the scanner to the laptop.

Compatible with: HandySCAN 3D (2nd Gen.)



ETHERNET CABLE 7.5-m

ACC-HPB-EC75

7.5-m (24-ft) Ethernet cable, connecting the controller to the laptop.

Compatible with: Controller (all Gen.)





USB 3.0 CABLE 8-m

ACC-CRE-CAU8

8-m (26-ft) USB 3.0 cable, connecting to controller or laptop.

Compatible with: MaxSHOT 3D (2nd Gen.), MetraSCAN 3D (3rd Gen.), HandySCAN 3D (3rd Gen.), GoSCAN 3D (3rd Gen.)



USB 3.0 CABLE 8-m

ACC-MTR-CAU8BL

8-m (26-ft) USB 3.0 cable, connecting the scanner to the controller.

Compatible with: MetraSCAN 3D (4th Gen.)



USB 3.0 CABLE 8-m

ACC-H3D-RFPUSB

8-m (26-ft) USB 3.0 cable, powered by the Rugged Field Pack, connecting the scanner to the laptop.

Compatible with: Rugged Field Pack with HandySCAN 3D (2nd Gen.) used together.



USB 3.0 CABLE 7.5-m

ACC-HPB-CC75N

7.5-m (24-ft) USB 3.0 cable, connecting the C-Track to the controller.

Compatible with: C-Track (3rd Gen.)



USB 3.0 CABLE 8-m

ACC-HPB-CAU8CTR

8-m (26-ft) USB 3.0 cable, connecting the C-Track to the controller.

Compatible with: C-Track (4th Gen.)



USB 3.0 CABLE 8-m

ACC-H3D-CUSB8

8-m (26-ft) USB 3.0 cable, powered by standard 18 V power supply, connecting the scanner to the laptop.

Compatible with: HandySCAN 3D (2nd Gen.)





USB 3.0 CABLE 16-m

ACC-CRE-CAU16

16-m (52-ft) USB 3.0 cable, connecting the photogrammetry system to the laptop.

Compatible with: MaxSHOT 3D (2nd Gen.), MetraSCAN 3D (3rd Gen.), HandySCAN 3D (3rd Gen.), Go!SCAN SPARK (3rd Gen.)



USB 3.0 CABLE 16-m

ACC-MTR-CAU16BL

16-m (52-ft) USB 3.0 cable, connecting the scanner to the controller.

Compatible with: MetraSCAN 3D (4th Gen.)



USB 3.0 CABLE 16-m

ACC-MTR-ROCA

16-m (52-ft) USB 3.0 Power & Synchro robotic cable for MetraSCAN 3D-R.

Compatible with: MetraSCAN 3D-R (3rd Gen.)



USB 3.0 CABLE 16-m

ACC-HPB-CTC16

16-m (52-ft) USB 3.0 cable, connecting the C-Track to the controller.

Compatible with: C-Track (3rd Gen.)



USB 3.0 CABLE 16-m

ACC-HPB-CAU16CTR

16-m (52-ft) USB 3.0 cable, connecting the C-Track to the controller.

Compatible with: C-Track (4th Gen.)



USB 3.0 CABLE 16-m

ACC-MTR-CAU16R

16-m (52-ft) USB 3.0 robotic cable for MetraSCAN 3D-R.

Compatible with: MetraSCAN 3D-R (4th Gen.)





USB/ETHERNET NETWORK ADAPTER

ACC-HPB-ENAN

Compact USB 3.0 to 10/100 Mbps Ethernet USB network adapter for convenient Ethernet connectivity. Simply connect the network adapter to the laptop and then connect the adapter to the Ethernet network.

Compatible with: Controller with C-Track (3rd Gen.)



USB/ETHERNET NETWORK ADAPTER

CC-HPB-ENAN4

Compact USB 3.0 to 10/100 Mbps Ethernet USB network adapter for convenient Ethernet connectivity. Simply connect the network adapter to the laptop and then connect the adapter to the Ethernet network.

Compatible with: Controller with C-Track (4th Gen.)





C-Link CONNECTION KIT

Multiple connection kit enabling the use of the C-Link functionality.
Includes: 1X Ethernet switch 5 port 10/100, 1X power supply 5V,
2X 20-m (65-ft) Ethernet cable, 2X 10-m (32-ft) Ethernet cable,
3X 10-m (32-ft) C-Link cable and plug boardchart.

Compatible with: C-Track (3rd Gen., 4th Gen.)





POWER SUPPLY 18V

ACC-CRE-PS18

Input: 100-240 V ~ 50-60 Hz 0.8 A.
Output: 18 V 1.66 A 19.92 W max.

Compatible with: HandySCAN 3D (2nd Gen.),
Go!SCAN 3D (2nd Gen.), MaxSHOT 3D (1st Gen.)
connected to computer



POWER SUPPLY 24V

ACC-HPB-PS24N

Input: 100-240 V 50-60 Hz 2.5 A.
Output: 24 V 6.67 A 160 W max.

Compatible with: Controller with C-Track (3rd Gen.,
4th Gen.)



POWER SUPPLY 24V

ACC-CRE-PS

Input: 100-240 V ~ 50-60 Hz 1.5 A.
Output: 24 V; 2.5A.

Compatible with: MaxSHOT 3D (2nd Gen.),
HandySCAN 3D (3rd Gen.), Go!SCAN 3D (3rd Gen.)





3D SCANNER EXTERNAL BATTERY

ACC-CRE-EBAT

Portable and lightweight external battery delivering up to three hours of autonomy.

Ideal for short-term projects and provides easier than ever access to confined spaces. Also comes with a power supply to charge the battery and a cable to connect the battery to the computer end of scanner cable.

Dimensions: 18 x 11 x 2 cm (7.1 x 4.3 x 0.8 in)

Weight: 0.52 kg (1.14 lb)

Compatible with: HandySCAN 3D (2nd Gen.), Go!SCAN 3D (2nd Gen.), MaxSHOT 3D (1st Gen.)

* Product may differ from the image



24V DOCKING SYSTEM WITH LITHIUM-ION BATTERY

ACC-CRE-BAT24V

Portable and lightweight external battery delivering up to four hours of autonomy.

24V docking system with lithium-ion battery.
Dimensions: 18.3 x 8.2 x 4.3 cm (7.2 x 3.2 x 1.7 in)
Weight: 0.62 kg (1.38 lb)

Compatible with: HandySCAN 3D (3rd Gen.), Go!SCAN 3D (3rd Gen.), MaxSHOT 3D (2nd Gen.)



SELF-POWER KIT²

ACC-HPB-BAT

Complementary battery with a switch box and a fixing kit enabling enhanced autonomy and mobility on the shop floor. Also comes with a power supply to charge the battery.

Compatible with: C-Track Shop-Floor Stand (1st Gen.)

(2) **Warning:** Should not be used as permanent power supply source and can only be used to maintain the system active on upon movement.

* Product may differ from the image





LAPTOPS

Laptops purchased with your Creaform solution have been tested and approved in accordance with recommended system requirements to ensure optimal performance. Should anything happen to your system, our certified laptops are fully supported by our customer support team.

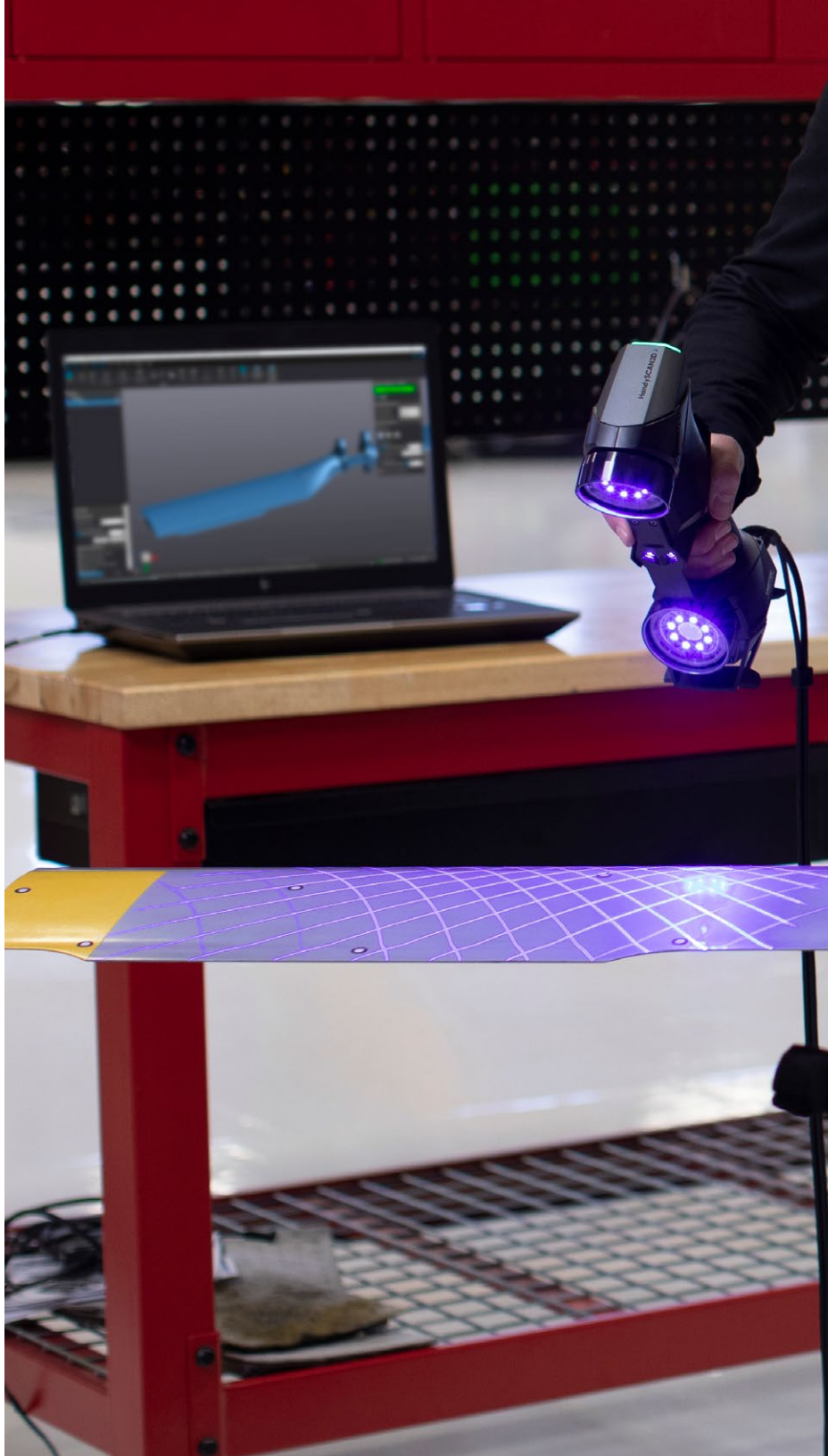

PLEASE CONTACT OUR
**TECHNICAL
 SUPPORT TEAM**
 TO HELP YOU FIND
 THE RIGHT COMPUTER.

RECOMMENDED SYSTEM REQUIREMENTS

	HandySCAN BLACK™, GoSCAN SPARK™, MetraSCAN BLACK™	OTHER PRODUCTS ⁽¹⁾
COMPUTER MODEL	HP ZBook 17	HP ZBook 15
PROCESSOR	Intel Core i7 (6+ cores) – 2.6 GHz or more ⁽²⁾	Intel Core i7 (6+ cores) – 2.6 GHz or more ⁽³⁾
OPERATING SYSTEM⁽⁴⁾	Windows 10 (64 bits)	
GRAPHICS CARD⁽⁵⁾	NVIDIA Quadro RTX5000, OpenGL 4.5 and higher	NVIDIA Quadro T1000, OpenGL 4.5 and higher
MEMORY	64 GB	32 GB
HARD DRIVE	Solid-state drive (SSD) with at least 200 GB of free space	
DISPLAY	1920 X 1080	
CONNECTING PORTS	USB 3.0. See devices specifications for more details.	
MICROSOFT EXCEL⁽⁶⁾	Excel 2016	

(1) HandyPROBE Next, HandySCAN 3D (2nd Gen), MetraSCAN 357, MaxSHOT 3D and ACADEMIA.

(2) Processor must support AVX2 instructions.

(3) Processor must support AVX instructions.

(4) 32-bits OS are not supported.

(5) Compatible only with NVIDIA graphic cards.

(6) Microsoft Excel is required for the following VXelements modules: VXinspect, VXinspect Scanning and VXinspect Probing, as well as the following software: Pipecheck, Pipecheck Analyze and SmartDENT 3D.



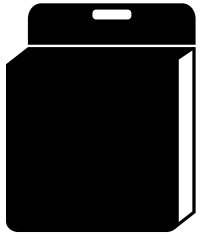

TARGETS

Each system has its own positioning target for optimized data acquisition.

[Contact our Creaform customer support agents](#)



-
- 18 / Legend
 - 19 / Coded Targets
 - 20 / Positioning Targets
 - 21 / Optical Reflectors

LEGEND

POSITIONING TARGETS

Retroreflective positioning targets are available in light or black contour for easier and more precise positioning.



Ø 3 mm
black contour



Ø 6 mm
black contour



Ø 12 mm
black contour

CODED TARGETS

Magnetic or adhesive targets with a specific and different pattern of reflectors used with the MaxSHOT 3D to increase the accuracy of the positioning model.



Ø 12 mm
reflector

TYPE

Retroreflective positioning targets are available in adhesive and magnetic application.



High adhesive



Adhesive (standard)



Light adhesive



Magnetic

REFLECTIVITY

High reflectivity targets are meant to reflect light-emitting diodes (LED) on a longer distance and are mostly used in photogrammetry.



High reflectivity



Avoid touching
the retroreflective
targets

CODED TARGETS FOR MaxSHOT 3D

PRODUCT NUMBER	SIZE	TYPE	REFLECTIVITY	QUANTITY	COMPATIBLE WITH
ACC-CRE-CT00AN	12			#31-240	MaxSHOT 3D, C-Track, C-Track Elite
ACC-CRE-CT00BN	12			#241-447	MaxSHOT 3D, C-Track, C-Track Elite
ACC-CRE-CT8M241N	12			#241-447	MaxSHOT 3D, C-Track, C-Track Elite
ACC-CRE-CT8M31N	12			#31-240	MaxSHOT 3D, C-Track, C-Track Elite



CODED TARGETS SUPPORT KIT

ACC-MSH-RIDSU











The kit includes: 20X steel plates, 10X 90° angled steel plates, 50X magnets and a carrying case (carrying case can accommodate 2 kits).

Compatible with: MaxSHOT 3D



POSITIONING TARGETS

REQUEST INFORMATION ABOUT
**FREE SHIPPING AND
VOLUME DISCOUNT**

PRODUCT NUMBER	SIZE	TYPE	REFLECTIVITY	QUANTITY	PACK OF 34 BOXES	COMPATIBLE WITH
ACC-CRE-PTBCR3MM			--	500/box	ACC-CRE-PTBCR3MM34	HandySCAN 3D (3 rd Gen.), Go!SCAN 20
ACC-CRE-PTBC3MM			--	500/box	ACC-CRE-PTBC3MM34	HandySCAN 3D (3 rd Gen.), Go!SCAN 20
ACC-CRE-PTBCR*			--	500/box	ACC-CRE-PTBCR34	HandySCAN 3D (all Gen.), Go!SCAN 50, Go!SCAN SPARK
ACC-CRE-PTBC*			--	500/box	ACC-CRE-PTBC34	HandySCAN 3D (all Gen.), Go!SCAN 50, Go!SCAN SPARK
ACC-CRE-PTBCM			--	250/box	--	HandySCAN 3D (all Gen.), Go!SCAN 50, Go!SCAN SPARK
ACC-CRE-PTHRBC*				500/box	ACC-CRE-PTHRBC34	MaxSHOT 3D (1 st Gen.), HandySCAN 3D (2 nd Gen.), Go!SCAN SPARK
ACC-CRE-PTHRBCR*				500/box	ACC-CRE-PTHRBCR34	MaxSHOT 3D (1 st Gen.), HandySCAN 3D (all Gen.), Go!SCAN SPARK
ACC-CRE-PTHRBCM				250/box	--	MaxSHOT 3D (1 st Gen.), HandySCAN 3D (all Gen.), Go!SCAN SPARK
ACC-CRE-REF12				250/box	--	C-Track (3 rd Gen., 4 th Gen.), MaxSHOT 3D (1 st Gen.)

POSITIONING TARGETS



OPTICAL REFLECTORS

Easy to remove, magnetic and reusable reflectors designed for metallic surfaces.

Glass-protected magnetic reflector



PRODUCT NUMBER	DESCRIPTION	COMPATIBLE WITH
ACC-CRE-R12MAG5	0° (Ø 12 mm), pack of 5	C-Track (3 rd Gen., 4 th Gen.), MaxSHOT 3D (all Gen.)
ACC-CRE-R12MAG10	0° (Ø 12 mm), pack of 10	C-Track (3 rd Gen., 4 th Gen.), MaxSHOT 3D (all Gen.)



PRODUCT NUMBER	DESCRIPTION	COMPATIBLE WITH
ACC-CRE-R12456	45° shaft (Ø 12 mm reflector - height 12 mm - Ø 6 mm pin)	C-Track (3 rd Gen., 4 th Gen.), MaxSHOT 3D (all Gen.)



PRODUCT NUMBER	DESCRIPTION	COMPATIBLE WITH
ACC-CRE-R12906	90° shaft (Ø 12 mm reflector - height 12 mm - Ø 6 mm pin)	C-Track (3 rd Gen., 4 th Gen.), MaxSHOT 3D (all Gen.)



PRODUCT NUMBER	DESCRIPTION
ACC-HPB-MS14	Magnetic base for swivel optical reflectors. Fits Ø 1/4" pin

OTHER MODELS AVAILABLE
PLEASE CONTACT
creaform.supportsales@ametek.com

Request information

© Creaform Inc. June 2021. All rights reserved.





PROBING

Creaform offers a variety of probes and extensions that allow the user to move freely around the part to achieve faster and easier measurements.



Straight styli are designed to inspect simple features where direct, unobstructed contact with a measured surface is possible. A stainless steel stem offers excellent rigidity and is ideal for applications where weight is not critical. Ruby is regarded as the industry standard for stylus tips. It is one of the hardest materials available and suitable for most applications. Due to adhesive pickup, ruby tips are not recommended for scanning aluminium parts.



PROBE REPLACEMENT

ACC-HPB-S2L20

Ruby probe, Ø 2 mm, 20 mm in length, M4 thread.

Compatible with: HandyPROBE (all Gen.)



PROBE REPLACEMENT

ACC-HPB-S3L20

Ruby probe, Ø 3 mm, 20 mm in length, M4 thread.

Compatible with: HandyPROBE (all Gen.)



PROBE REPLACEMENT

ACC-HPB-S3L50

Ruby probe, Ø 3 mm, 50 mm in length, M4 thread.

Compatible with: HandyPROBE (all Gen.)



PROBE REPLACEMENT

ACC-HPB-S6L20

Ruby probe, Ø 6 mm, 20 mm in length, M4 thread.

Compatible with: HandyPROBE (all Gen.)





PROBE REPLACEMENT

ACC-HPB-S05L10

Half sphere probe, Ø 0,5 in, 10 mm in length, M4 thread.

Compatible with: HandyPROBE (all Gen.)



PROBE REPLACEMENT

ACC-HPB-S12L10

Half-sphere probe, Ø 12 mm, 10 mm in length, M4 thread.

Compatible with: HandyPROBE (all Gen.)

Hemispherical styli are designed for the inspection of rough surfaces and deep features, such as bores. Half-sphere probe made of Silicon nitride.



PROBE REPLACEMENT

ACC-HPB-S16L10

Half-sphere probe, Ø 16 mm, 10 mm in length, M4 thread.

Compatible with: HandyPROBE (all Gen.)



PROBE REPLACEMENT

ACC-HPB-L15PP

Point probe, 15 mm in length, packaged with M2/M4 adapter.

Pointer styli are designed to inspect threaded forms, specific points and scribed lines. Tungsten carbide tips are ideal for applications demanding a hardwearing interface with an inspected item.

Compatible with: HandyPROBE (all Gen.)



PROBE ADAPTER

ACC-HPB-PA90E

90° elbow probe adapter.

A swivel adaptor allows the user to align the stylus in a variety of orientations.

Compatible with: HandyPROBE (all Gen.)



STYLUS TOOL

ACC-HPB-M4ST

Small key used to tighten or loosen probes and extensions.

Compatible with: HandyPROBE (all Gen.)





CERAMIC STYLUS EXTENSION

ACC-HPB-A50EC

50 mm ceramic stylus extension, M4 thread.

Compatible with: HandyPROBE (all Gen.)



CERAMIC STYLUS EXTENSION

ACC-HPB-A100EC

100 mm ceramic stylus extension, M4 thread.

Compatible with: HandyPROBE (all Gen.)



CERAMIC STYLUS EXTENSION

ACC-HPB-A200EC

200 mm ceramic stylus extension, M4 thread.

Compatible with: HandyPROBE (all Gen.)

Extensions are designed to be used when measuring very deep features and bores or when probing points with limited access. Ceramic extensions are lightweight yet very stiff and offer built-in crash protection.





SmartConnect PROBE ADAPTER

ACC-HPB-SCPA

Renishaw probe adapter to easily change stylus configurations.

Compatible with: HandyPROBE (3rd Gen., 4th Gen.)



SmartConnect PROBE ADAPTER TOOL

ACC-HPB-SCPAT

Tool to fix the SmartConnect adapter on the HandyPROBE stylus.

Compatible with: HandyPROBE (3rd Gen., 4th Gen.)



STAINLESS STEEL STYLUS EXTENSION

ACC-HPB-E10M4

10 mm stainless steel stylus extension, M4 thread.

Extensions are designed to be used when measuring very deep features and bores or when probing points with limited access. Stainless steel extensions offer excellent rigidity and are ideal for applications where weight is not critical.

Compatible with: HandyPROBE (all Gen.)



CALIBRATION SPHERE

ACC-HPB-CPH

Calibration sphere HandyPROBE with support

Compatible with: HandyPROBE (3rd Gen., 4th Gen.)





CASES AND SUPPORTS

Our carry-on cases and scanner supports have been designed to follow you wherever you need to go—whether in-house or on-site. Each scanner comes with a scanner stand for safe and stable support in your work environment. It's portability where you need it!



29 / Carry-on Cases

30 / Supports

CARRY-ON CASES

PRODUCT NUMBER	DESCRIPTION	COMPATIBLE WITH
ACC-G3D-G20CC	Ergonomic protective case equipped with a custom foam insert. Dimensions: 43.38 x 37.96 x 18.80 cm (17.08 x 14.84 x 7.40 in)	Go!SCAN 20
ACC-G3D-G50CC	Ergonomic protective case equipped with a custom foam insert. Dimensions: 43.38 x 37.96 x 18.80 cm (17.08 x 14.84 x 7.40 in)	Go!SCAN 50
ACC-G3D-SPCC	Ergonomic protective case equipped with a custom foam insert. Dimensions : 48.7 x 38.6 x 18.5 cm (19.2 x 15.2 x 7.3 in)	Go!SCAN SPARK
ACC-H3D-H37CC	Ergonomic protective case equipped with a custom foam insert. Dimensions: 48.7 x 38.6 x 18.5 cm (19.2 x 15.2 x 7.3 in)	HandySCAN 3D (2 nd Gen.)
ACC-H3D-CCBLA	Ergonomic protective case equipped with a custom foam insert. Dimensions: 48.7 x 38.6 x 18.5 cm (19.2 x 15.2 x 7.3 in)	HandySCAN BLACK
ACC-HPB-NEXTCC	Ergonomic protective case equipped with a custom foam insert. Dimensions: 122.6 X 31.4 X 40.6 cm (48.25 X 12.38 X 16.00 in)	HandyPROBE Next, HandyPROBE Next Elite
ACC-MTR-MTRC2	Ergonomic protective case equipped with a custom foam insert. Dimensions: 62.86 x 37.46 x 50.16 cm (24.75 x 14.75 x 19.75 in)	MetraSCAN 350/750
ACC-MSH-MNCC	Ergonomic protective case equipped with a custom foam insert. Dimensions: 136.7 x 41.9 x 17 cm (53.8 x 16.5 x 6.7 in)	MaxSHOT 3D
ACC-MTR-PBCC	Ergonomic protective case equipped with a custom foam insert. Dimension: 78.74 X 13.97 X 12.70 cm (31 x 5.5 x 5 in)	Precision bar 648 mm with MetraSCAN 3D, HandyPROBE
ACC-HPB-NEXTACP	Ergonomic protective case equipped with a custom foam insert for probe accessory kit. Dimensions: 20.0 X 4.3 X 16.5 cm (7.87 X 1.69 X 6.50 in)	HandyPROBE (Probing accessory kit)
ACC-HPB-NEXTACT	Ergonomic protective case equipped with a custom foam insert for target accessory kit. Dimensions: 23.4 X 5.4 X 20.5 cm (9.21 X 2.13 X 8.07 in)	HandyPROBE (Target accessory kit)
ACC-MTR-CCMTRBL	Ergonomic protective case equipped with a custom foam insert. Dimensions: 62.86 x 37.46 x 50.16 cm (24.75 x 14.75 x 19.75 in)	MetraSCAN BLACK
ACC-HPB-NEXTCC4	Ergonomic protective case equipped with a custom foam insert. Dimensions: 122.6 X 31.4 X 40.6 cm (48.25 X 12.38 X 16.00 in)	C-Track (4 th Gen.)
ACC-MTR-CCMTRBR	Ergonomic protective case equipped with a custom foam insert. Dimensions: 62.86 x 37.46 x 50.16 cm (24.75 x 14.75 x 19.75 in)	MetraSCAN-R BLACK





EXTENSION POLE

ACC-MSH-PRM

MaxSHOT 3D extension pole of 3.3 m (10 ft) with remote control to help in difficult to reach areas.

Compatible with: MaxSHOT 3D (2nd Gen.)

* MaxSHOT 3D sold separately



SWIVEL HEAD

ACC-HPB-SHS

Support holding the C-Track sensor onto the tripod.

Compatible with: C-Track (all Gen.)



TRIPOD

ACC-HPB-TRI

Sturdy aluminum tripod with extendable and adjustable legs based on a solid center brace structure.

Compatible with: C-Track (all Gen.)



DYNAMIC REFERENCING KIT

ACC-HPC-TRIDEC

C-Track calibration bar holder and tripod for Dynamic Environment Compensation

Compatible with: C-Track (3rd Gen., 4th Gen.)





C-TRACK SHOP-FLOOR STAND WITH SELF POWER KIT¹

ACC-HPB-SFS20SPK

Stand on wheels with extendable pole and dedicated place for the controller, the MetraSCAN 3D and the HandyPROBE. Self power kit includes docking and two batteries. Additional batterie also available (ACC-CRE-BAT14).

Dimensions: 550 x 700 x 1200 mm (22 x 28 x 47 in)
Weight: 32 kg (71 lb)

Compatible with: C-Track (4th Gen.)²



C-TRACK SHOP-FLOOR STAND¹

ACC-HPB-SFS20

Stand on wheels with extendable pole and dedicated place for the controller, the MetraSCAN 3D and the HandyPROBE.

Dimensions: 550 x 700 x 1200 mm (22 x 28 x 47 in)
Weight: 32 kg (71 lb)

Compatible with: C-Track (3rd Gen., 4th Gen.)²



LITHIUM-ION BATTERY

ACC-CRE-BAT14

Portable and lightweight external battery delivering up to four hours of autonomy.

Battery must be used in pair with the 24V docking station or the C-Track Shop-Floor stand docking station.
Dimensions : 15 x 7.7 x 2.3 cm (5.9 x 3 x 0.89 in)
Weight: 0.44 kg (0.97 lb)

Compatible with: C-Track Shop Floor Stand (2nd Gen.)



CABLE 2,4-m

ACC-HPB-CAUCTR

2.4-m (8-ft) USB 3.0 cable connecting the C-Track to the controller for C-Track Shop-Floor Stand usage.

Compatible with: C-Track (4th Gen.)

(1) Self power only available with initial purchase of SFS. Cannot be sold separately.

(2) C-Track, MetraSCAN 3D, HandyPROBE, calibration bar, controller and power supply sold separately.



MAGNETIC SUPPORT

ACC-H3D-FPKMSH3D

Magnetic support designed for scanners.

Compatible with: HandySCAN 3D (2nd Gen., 3rd Gen.)



MAGNETIC SUPPORT KIT FOR SCALE BARS

ACC-MSH-MSSB

Kit of 2 magnetic support clamps for scale bars.

Compatible with: MaxSHOT 3D (2nd Gen.)





VALUE-ADDED

Make the most out of your Creaform solution with these value-added accessories that have been designed to optimize your 3D scanning experience and enhance your productivity.

Creaform accessories give you the possibility to take your solution to the next level.





CREAFORM PORTABLE WORKSTATION (HandySCAN 3D AND Go!SCAN 3D)

ACC-CRE-CPW

Creaform portable workstation includes: custom carrying case with foams, all-terrain wheels and mobile desk. Designed for Creaform certified laptops.

Compatible with: HandySCAN 3D (2nd Gen., 3rd Gen), Go!SCAN 3D (3rd Gen.)

CREAFORM PORTABLE WORKSTATION (MetraSCAN 3D)

ACC-CRE-CWP20

Creaform portable workstation includes: custom carrying case with foams, all-terrain wheels and mobile desk. Designed for Creaform certified laptops.

Compatible with: MetraSCAN 3D (3rd Gen., 4th Gen.)





VALUE-ADDED

VALUE-ADDED

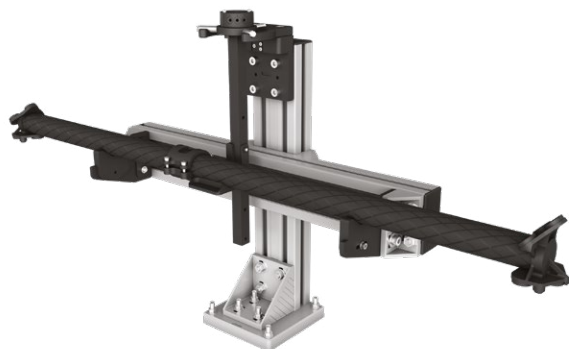

R-Series AUTOCALIBRATION KIT

ACC-MTR-TOCH

Assembly of all necessary components for C-Track automatic calibration.

Compatible with: MetraSCAN 3D-R (1st Gen.)



R-Series MOUNTING PLATE

ACC-CUB-MOPL

R-Series mounting plate.

Compatible with: CUBE-R (1st Gen.)



TARGET SATELLITE

ACC-MTR-TS1

Octagonal glass-protected target accessory kit designed for automated photogrammetry and manual C-Track movement around the part. Design to be mounted on fixture. Also available in pack of 10 (ACC-MTR-TSK10)

Compatible with: C-Track (all Gen.), MaxSHOT (all Gen.) and CUBE-R (all Gen.)





3D SCANNING TURNTABLE

ACC-CRE-TT

Dimensions: 400 mm (16 in) diameter and 18 mm (3/4 in) high. Maximum load of 180 kg. Manual turntable to facilitate the scanning of small objects. Offers an alternative to applying positioning targets on the part itself (optional).

Compatible with: HandySCAN 3D (all Gen.), Go!SCAN 3D (all Gen.)



TRIANGULAR REFERENCES (SET OF 15)

ACC-G3D-TR

Designed for the Go!SCAN 20, these triangular scan references provide targets¹ at a 45° angle to facilitate the capture process even more. Stand-alone or used in combination with the 3D scanning turntable, simply place the triangular references around the object and start scanning.

Compatible with: Go!SCAN 20

(1) 3 mm (1/8 in) positioning targets sold separately.





HandyPROBE AND MetraSCAN 3D TARGET ACCESSORY KIT

ACC-HPB-AKTNEXT

Starter kit of swivel reflectors and glass-protected reflectors for HandyPROBE and MetraSCAN 3D. The kit includes: 2X Ø 12 mm reflector @ 45°, 6X Ø 12 mm reflector @ 90°, (Ø 6 mm pin, height 12 mm), 10X glass-protected magnetic reflector Ø 12 mm @ 0°, 8X magnetic base for Ø 6 mm pin.

Compatible with: HandyPROBE (3rd Gen., 4th Gen.), MetraSCAN 3D (3rd Gen., 4th Gen.)

PROBE ACCESSORY KIT

ACC-HPB-AKPNEXTSC

Starter kit of probe accessories for HandyPROBE. The kit includes: 1X Smart connect probe adaptor, 1X 100 mm M4 ceramic probe extension, 1X 50 mm M4 ceramic probe extension, 1X Calibration sphere, 1X Point Probe 15 mm, 1X Probe - Ø 3 mm ruby-L20-M4, 1X 90 elbow probe adapter.

Compatible with: HandyPROBE (3rd Gen., 4th Gen.)

* Casing sold separately ACC-HPB-NEXTACP

OPTICAL PROBING ACCESSORY KIT

ACC-CRE-PHOACC

Starter kit of optical probing accessories for MaxSHOT 3D or HandyPROBE. The kit includes: half-spheres for hole positioning (2X SBR Ø 0.5 in-6 mm target, 8X SBR Ø 1.5 in-12 mm target, edge nest for edge location (4X TCR - 12 mm), 10X glass-protected magnetic targets for surface points and a carrying case (carrying case can accommodate more accessories).

Compatible with: MaxSHOT 3D (2nd Gen.)





SCRAPERS FOR TARGETS (SET OF 5)

ACC-CRE-SCR

Plastic scrapers to facilitate gentle removal of adhesive targets.

Pack of 3 without pouch also available ACC-CRE-SCR3.



CABLE MANAGEMENT ACCESSORIES KIT

ACC-MSH-CBAK

Kit of 2 cable management accessories: 25-mm (1-in) clamp and RJ45 (Network jack) .





REFERENCE ARROW

ACC-H3D-REFA

The reference arrow allows the origin of the analysis grid and the flow direction. Comes in a protective Pelican case.

Compatible with: Pipecheck



LONG-SCALE BAR KIT

ACC-MSH-SBLK

Invar long-scale bars extension kit. The kit includes: invar extensions 4X 1 m (40 in), invar extensions 2X 0.5 m (20 in), 4X extension connecting screws, 4X reflector holders, 4X reflectors, 4X coded targets clips, 4X scale bar supports, calibration certificate and a carrying case.

Compatible with: MaxSHOT 3D (all Gen.)



PRECISION BAR WITH CARRYING CASE

ACC-MTR-NEXTPBK

Includes a 0.65 m (26 in) ball-and-cone combo bar used to verify and/or demonstrate the accuracy of the MetraSCAN 3D, the HandyPROBE and the HandySCAN 3D. Also comes with a protective case equipped with a custom foam insert for easy and safe transportation.

Compatible with: MetraSCAN 3D (3rd Gen., 4th Gen.), HandyPROBE, HandySCAN 3D (all Gen.), Go!SCAN 3D (all Gen.)



CREAFORM

AMETEK[®]
ULTRA PRECISION TECHNOLOGIES

Creaform Inc. (Head Office)

4700 rue de la Pascaline
Lévis QC G6W 0L9
Canada

creaform3d.com

DISTRIBUIDOR OFICIAL:

AsorCAD[®]
Expertos en tecnología 3D

HandySCAN 3D, HandySCAN BLACK, HandySCAN BLACK|Elite, HandySCAN 307, HandySCAN 700, MetraSCAN 3D, MetraSCAN BLACK, MetraSCAN BLACK|Elite, MetraSCAN 350, MetraSCAN 750, MetraSCAN 3D-R, MetraSCAN-R BLACK, MetraSCAN-R BLACK|Elite, HandyPROBE, HandyPROBE Next, C-Track, C-Track Next, C-Track|Elite, C-Track 380, C-Track 780, C-Track 1480, C-Link, MaxSHOT 3D, MaxSHOT Next, MaxSHOT Next|Elite, Go!SCAN 3D, Go!SCAN SPARK, Go!SCAN 20, Go!SCAN 50, CUBE-R, VXelement, Pipecheck and their respective logos are trademarks of Creaform Inc. © Creaform Inc. 2021. All rights reserved.